

# Aesculap® Acculan 3Ti

Look. Feel. Experience.



# Acculan 3Ti

## Look. Feel. Experience.

Aesculap, as one of the leading suppliers of surgical motor systems, provides intelligent solutions for each surgical discipline. Our philosophy is to develop well-designed systems to make everyday hospital work easier: for the surgeon during the operation, for the operating team and for staff in charge of handling and sterile setup. With the Acculan 3Ti we have addressed this challenge in a completely new way.

This is a machine that will convince from the first second you touch it. The rounded, organic shape and the handle with integrated battery allow precise guidance and good grip. You will feel the difference. The stylish titanium housing is nearly indestructible.

Experience it yourself: Acculan 3Ti is a high-performance motor system for intuitive operation, meeting high standards of reliability, durability and ergonomics.



The difference  
is in the detail.



■ **The principal:  
We don't sterilize the battery**

Aesculap pioneered the use of rechargeable batteries, which do not come into contact with the sterile external surfaces of the handpieces. This design concept prevents the need to sterilize temperature sensitive battery cells. This enhances the service life, increases usage time and offers greater reliability.

Consequently this design concept has now been widely accepted and emulated.

■ **The difference is in the detail**

Acculan 3Ti avoids sterilization not only of the temperature-sensitive battery cells, but also of the equally vulnerable control electronics by integrating it in the battery unit.

Acculan 3Ti represents the consistent development of our philosophy.

# Acculan 3Ti

## Look. Feel. Experience.



Aesculap engineers designed the handpieces with high reliability by keeping the sensitive battery control unit inside the non-sterile battery.

### ■ Powerfull and reliable

The novel motor and control concept offers the kind of performance previously found only in our pneumatic or cable systems, combined with the reliability of our legendary Elan flexible cable system.

### ■ Intuitive operation

The Acculan 3Ti is easy to operate, especially with its intuitive saw blade coupling mechanism or the new K-wire attachment.

### ■ Automatic battery check

The battery charger automatically checks the condition of the battery after each charging cycle. It indicates when a battery shows declining performance and should be replaced.

### ■ Mechanical processing

With the ECCOS storage system and the titanium shell, the Acculan 3Ti is suitable for mechanical cleaning, even with alkaline cleaning media. And ECCOS makes sure that the system is clearly arranged for its sterile setup in the O.R.



### ■ Low running costs

For the Acculan 3Ti we offer the replacement of spent batteries at an attractive fixed price. As the electronics and housing can still be used, this is a solution that is friendly to the environment and to your budget.

### ■ Service label

Regular servicing is essential to ensure the reliability of motor systems over a long service life. The service label clearly shows when the next Aesculap service is due.

# Acculan 3Ti Overview



- Easy coupling of attachments thanks to innovative Acculan 3Ti coupling.
- Special adapter for mechanical cleaning of 4.0 mm cannulation.

## ■ Drill and reamer motor unit GA672

The power house for universal use with attachments for acetabulum reaming, intramedullary reaming, drilling and K-wire application; especially for application in endoprosthetics.

## ■ Small drill motor unit GA671

- Smaller size and lower weight than its "big brother" GA672. Especially designed for all traumatological applications, e.g. drilling, intramedullary reaming and K-wire insertion, as well as, in connection with saw attachment GB660R, for all minor sawing procedures.

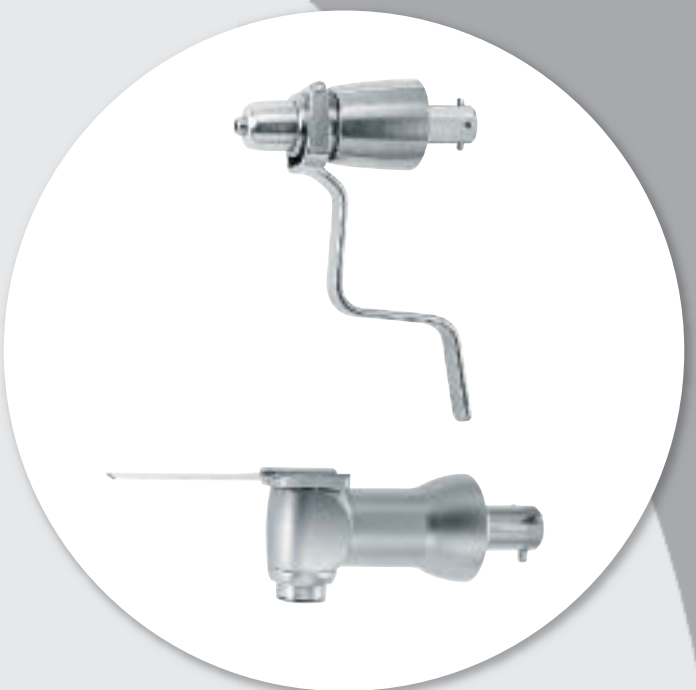

### ■ Acculan 3Ti attachments

Various attachments make the Acculan 3Ti adaptable for a range of applications without any compromise regarding user comfort and performance – high-speed for precise drilling, high torque for reaming.

- Compatible with all common reaming and drilling tools; attachments for A0, Zimmer, Hudson, Harris and Aesculap hexagon tool shaft.
- Easy identification of different drill and reamer attachments through color code on the unlocking sleeve. Drilling = black, reaming = blue.
- New K-wire attachment for intuitive operation. Suitable for all common K-wire diameters up to 4.0 mm.
- Sagittal saw attachment, for all minor sawing procedures; effective saw blade length of up to 50 mm – with the proven key-less rapid-action saw blade coupling.
- Adaptor for Synthes radiolucent drive.

# Acculan 3Ti Overview



## ■ Oscillating saw GA673

- Saw head 360° rotatable – for good access and visibility of the operating site.
- Key-less rapid-action saw blade coupling: Simply insert the saw blade – that's it. To release, just press the unlocking button and pull out the saw blade.

## ■ Reciprocating saw GA674

- Keyless saw blade coupling
- Application as a sternum saw (in combination with protection guide GB436R)





### ■ Charger GA677

- Intuitive, clear indicator elements
- Automatic battery check
- Charge status display
- Electronically controlled charging to avoid memory effect

### ■ Rechargeable battery GA676 and GA666

Innovative battery changing concept – good for the environment, good for your budget

# Ordering information

## Machines\*

GA671 Acculan 3Ti small drill\*



GA672 Acculan 3Ti Drill and reamer\*



## Acculan 3Ti attachments for GA671 and GA672

GB630R Drill attachment Zimmer / Hudson  
 GB634R Drill attachment Jacobs keyless 0.6 - 7.4 mm  
 GB635R Drill attachment AO small  
 GB636R Drill attachment Aesculap hexagon  
 GB638R Drill attachment Jacobs chuck 0.6 - 7.4 mm  
 GB637R Drill attachment Trinkle

GB654R Reamer attachment Harris  
 GB655R Reamer attachment AO large  
 GB656R Reamer attachment Zimmer / Hudson  
 GB658R Reamer attachment Jacobs chuck 0.6 - 7.4 mm

GB643R K-wire attachment 0.6 - 4.0 mm



GB645R Adapter for Synthes® radiolucent drive 511.300

GB660R Sagittal saw attachment  
 (for saw blades with a maximal length of 50 mm)





\*All Acculan 3Ti machines are supplied with battery, cover and sterile funnel as standard accessories.

## Machines\*

<p>GA673 Acculan 3Ti Oscillating saw*</p>	
<p>GA674 Acculan 3Ti Reciprocating saw*  <ul style="list-style-type: none"> <li>■ GB436R Acculan 3Ti protection guide for sternotomy</li> </ul> </p>	

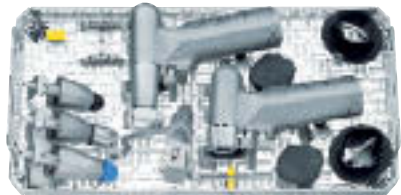
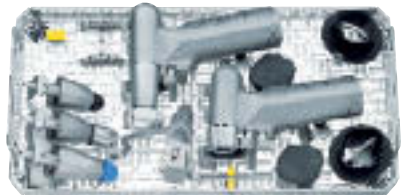
## Accessories

<p>GA677 Charger (power cord not included)          GA666 NiMH rechargeable battery for GA670, GA671          GA676 NiMH rechargeable battery for GA672, GA673, GA674          GA675 Lid          GA678 Sterile funnel          GA679 Battery removal device          GB600 Sterilit power systems oil spray </p>	
<p>GB243R Eccos set for 2 machines</p>	
<p>GB244R Eccos set for 1 machine          JK442 Bottom for 1/1 Container suitable for GB243R and GB244R          JK489 Full-size lid suitable for JK442</p>	

Machines and attachments are not within the scope of delivery of the Eccos set.

\*All Acculan 3Ti machines are supplied with battery, cover and sterile funnel as standard accessories.



# Saw blades



Article no. 	Effective length 	Width 	Cut width 
GC203R	25 mm	10 mm	0.5 mm
GC207R	25 mm	5 mm	0.5 mm
GC208R	25 mm	15 mm	0.5 mm
GC209R	35 mm	10 mm	0.8 mm
GC211R	35 mm	20 mm	0.8 mm
GC215R	50 mm	10 mm	0.8 mm
GC216R	50 mm	15 mm	0.8 mm
GC217R	50 mm	20 mm	0.9 mm
GC218R	50 mm	25 mm	0.9 mm
GC219R	50 mm	30 mm	0.9 mm
GC675R	50 mm	40 mm	0.9 mm
GC681R	35 mm	75 mm	0.9 mm

with depth stop



Article no. 	Effective length 	Cut width 
GC761R	34 mm	1.3 mm
GC766R	43 mm	0.9 mm
GC767R	60 mm	0.9 mm
GC768R	75 mm	0.9 mm
GC769R	75 mm	1.2 mm
GC770R	75 mm	0.9 mm
GC771R	75 mm	1.2 mm

for use with protection guide GB436R



Artikel-Nr.	Nutzlänge	Breite	Schnittspalt
GE252R	65 mm	20 mm	0.90 mm
GE253R	65 mm	26 mm	0.90 mm
GE254R	65 mm	32 mm	0.90 mm
GE255R	65 mm	41 mm	0.90 mm
GE231SU	75 mm	9 mm	1.27 mm
GE232SU*	90 mm	13,5 mm	1.47 mm
GE233SU*	90 mm	13,5 mm	1.27 mm
GE234SU	90 mm	13 mm	0.89 mm
GE235SU	90 mm	13 mm	1.00 mm
GE236SU	90 mm	13 mm	1.27 mm
GE238SU	90 mm	19 mm	0.89 mm
GE239SU	90 mm	19 mm	1.00 mm
GE240SU	90 mm	19 mm	1.19 mm
GE241SU	90 mm	19 mm	1.27 mm
GE242SU	90 mm	19 mm	1.37 mm
GE243SU	90 mm	23 mm	0.89 mm
GE244SU	90 mm	23 mm	1.00 mm
GE245SU	90 mm	23 mm	1.19 mm
GE246SU	90 mm	23 mm	1.27 mm
GE247SU	90 mm	23 mm	1.37 mm
GE248SU	90 mm	23 mm	1.47 mm
GE249SU	100 mm	19 mm	1.27 mm

\* Saw blades for minimal invasive technique.

Aesculap AG | Am Aesculap-Platz | 78532 Tuttlingen | Germany  
Phone +49 7461 95-0 | Fax +49 7461 95-26 00 | [www.aesculap.com](http://www.aesculap.com)

Aesculap – a B. Braun company

The main product mark 'Aesculap' is an  
registered mark of Aesculap AG.

Subject to technical changes. All rights reserved.  
This brochure may only be used for the exclusive  
purpose of obtaining information about our  
products. Reproduction in any form partial or  
otherwise is not permitted.

Brochure No. 031002

0414/1/7